

Job Name _____

Contractor _____

Job Location _____

Approval _____

Engineer _____

Contractor's P.O. No. _____

Approval _____

Representative _____

Series 957RPDA, 957NRPDA, 957ZRPDA

Reduced Pressure Detector Assemblies

Sizes: 2½" – 10"

Series 957RPDA, 957NRPDA, 957ZRPDA Reduced Pressure Detector Assemblies provide protection to the potable water system from contamination in accordance with national plumbing codes. The 957RPDA, 957NRPDA, 957ZRPDA are normally used in health hazard applications to protect against back-siphonage and backpressure. The Watts 957RPDA, 957NRPDA, 957ZRPDA are used to monitor unauthorized use of water from the fire protection system.

Features

- Extremely compact design
- 70% lighter than traditional designs
- 304 (Schedule 40) stainless steel housing & sleeve
- Groove fittings allow integral pipeline adjustment
- Patented torsion spring check provides lowest pressure loss
- Unmatched ease of serviceability
- Replaceable check disc rubber
- Available with grooved butterfly valve shutoffs
- Bottom mounted cast stainless steel relief valve
- Metered bypass to detect leakage or theft of water from the fire sprinkler system

⚠ WARNING

It is illegal to use this product in any plumbing system providing water for human consumption, such as drinking or dishwashing, in the United States. Before installing standard material product, consult your local water authority, building and plumbing codes.



957NRPDAOSY

Specifications

The Reduced Pressure Detector Assembly shall consist of two independent torsion spring check modules, a differential pressure relief valve located between and below the two modules, two drip tight shutoff valves, and required torsion spring check modules and relief valve shall be contained within a sleeve accessible single housing constructed from 304 (Sch 40) stainless steel pipe with groove end connections. Torsion spring checks shall have reversible elastomer discs and in operation produce drip tight closure against reverse flow caused by backpressure or backsiphonage. The bypass line shall include a meter, small diameter reduced pressure zone assembly and isolation valves. Assembly shall be Watts Series 957RPDA, 957NRPDA, 957ZRPDA.

NOTICE

The information contained herein is not intended to replace the full product installation and safety information available or the experience of a trained product installer. You are required to thoroughly read all installation instructions and product safety information before beginning the installation of this product.

Available Models

Suffix:

- OSY – UL/FM outside stem and yoke, resilient seated gate valves
- BFG – UL/FM grooved gear operated butterfly valves with tamper switch

*OSY FxG – Flanged inlet gate connection and grooved outlet gate connection

*OSY GxF – Grooved inlet gate connection and flanged outlet gate connection

*OSY GxG – Grooved inlet gate connection and grooved outlet gate connection

Available with grooved NRS gate valves - consult factory*

Post indicator plate and operating nut available - consult factory*

*Consult factory for dimensions

Materials

Housing & Sleeve: 304 (Schedule 40) Stainless Steel

Elastomers: EPDM, Silicone and Buna 'N'

Torsion Spring Checks: Noryl®, Stainless Steel

Check Discs: Reversible Silicone or EPDM

Test Cocks: Lead Free* Bronze Body

Pins & Fasteners: 300 Series Stainless Steel

Springs: Stainless Steel

Pressure – Temperature

Temperature Range: 33°F – 140°F (0.5°C – 60°C)

Maximum Working Pressure: 175psi (12.1 bar)

Approvals

- Approved by the Foundation for Cross-Connection Control and Hydraulic Research at The University of Southern California (FCCCHR-USC)
(Excluding 'N' Pattern – 10" 'Z', Pattern – 6" and 10")
- AWWA C511-97

Dimensions – Weight

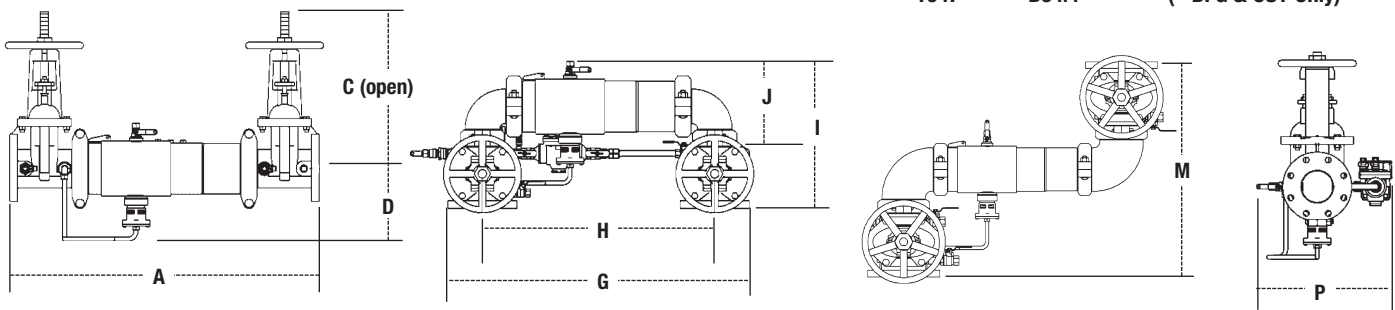

957RPDA, 957NRPDA, 957ZRPDA

SIZE	DIMENSIONS																WEIGHT					
	A		C (OSY)		D		G		H		I		J		M		P		957RPDA		957NRPDA	
in.	in.	mm	in.	mm	in.	mm	in.	mm	in.	mm	in.	mm	in.	mm	in.	mm	in.	mm	lbs.	kgs.	lbs.	kgs.
2½	30¾	781	16⅞	416	6½	165	29⅞	738	21½	546	15½	393	8⅜	223	21¼	540	13⅜	335	142	64	150	68
3	31¾	806	18⅞	479	6⅞	170	30¼	768	22¼	565	17⅞	435	9⅞	233	23	584	14½	368	162	73	175	79
4	33¾	857	22¼	578	7	178	33	838	23½	597	18½	470	9⅞	252	26¼	667	15⅞	386	178	81	201	91
6	43½	1105	30⅞	765	8½	216	44¾	1137	33¼	845	23⅞	589	13⅞	332	32¼	819	19	483	312	142	353	160
8	49¾	1264	37¾	959	9⅞	246	54⅞	1375	40⅞	1019	27⅞	697	15⅞	399	36⅞	937	21⅞	538	497	225	572	
10	57¾	1467	45¾	1162	23⅞	605	8⅞	208	66	1676	49½	1257	32½	826	17⅞	440	20	508	721	327	781	354

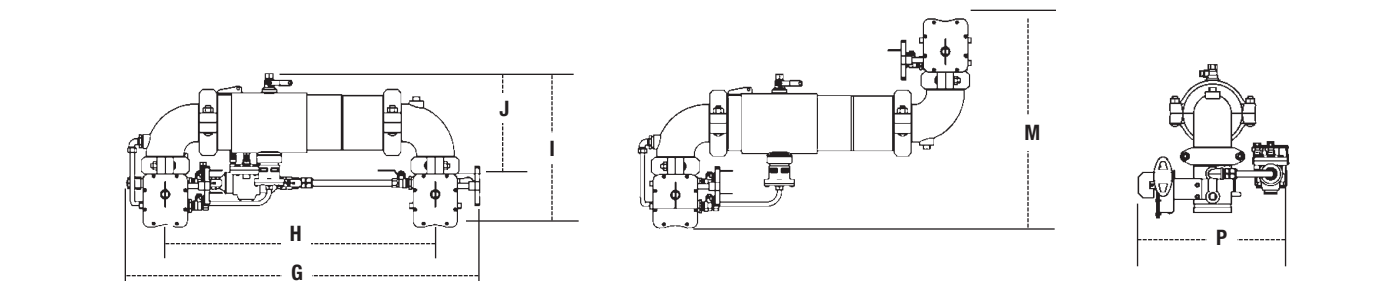

957NRPDABFG, 957ZRPDABFG

SIZE	DIMENSIONS										WEIGHT			
	G		H		I		J		M		P		957RPDABFG	
in.	in.	mm	in.	mm	in.	mm	in.	mm	in.	mm	in.	mm	lbs.	kgs.
2½	32½	826	23	584	15½	394	9½	241	19¾	502	15⅞	402	81	37
3	34	864	24	610	16⅞	414	10⅞	256	21¼	540	16⅞	410	84	38
4	35⅞	905	25½	648	17⅞	437	10⅞	279	23½	597	16⅞	422	101	46
6	46½	1181	35¼	895	20½	521	13½	343	27¼	692	19	483	174	79

Noryl® is a registered trademark of SABIC Innovative Plastics Holding BV.

Capacity

Series 957RPDA, 957NRPDA, 957ZRPDA flow curves as tested by Underwriters Laboratory.

Flow characteristics collected using butterfly shutoff valves

—— Horizontal ——— N-Pattern - - - - - Z-Pattern

Flow capacity chart identifies valve performance based upon rated water velocity up to 25fps

- Service Flow is typically determined by a rated velocity of 7.5fps based upon schedule 40 pipe.
- Rated Flow identifies maximum continuous duty performance determined by AWWA.
- UL Flow Rate is 150% of Rated Flow and is not recommended for continuous duty.
- AWWA Manual M22 [Appendix C] recommends that the maximum water velocity in services be not more than 10fps.

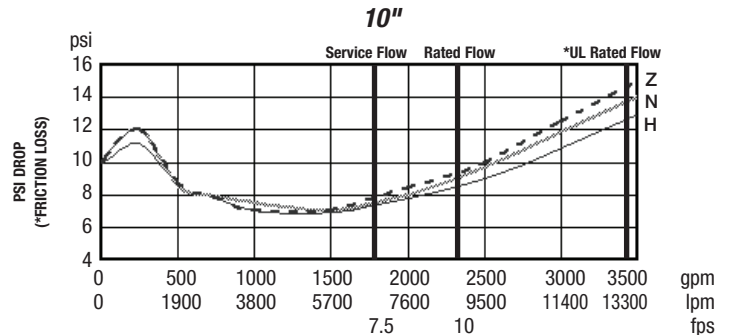
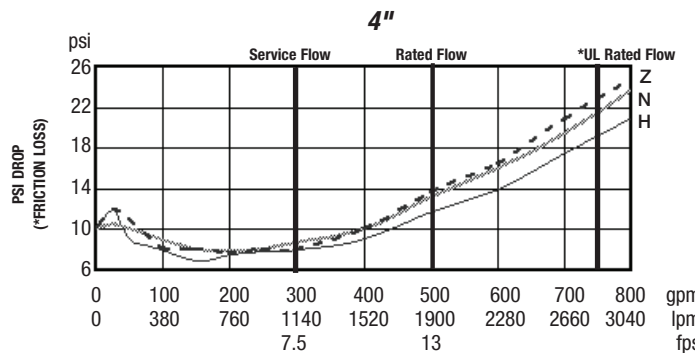
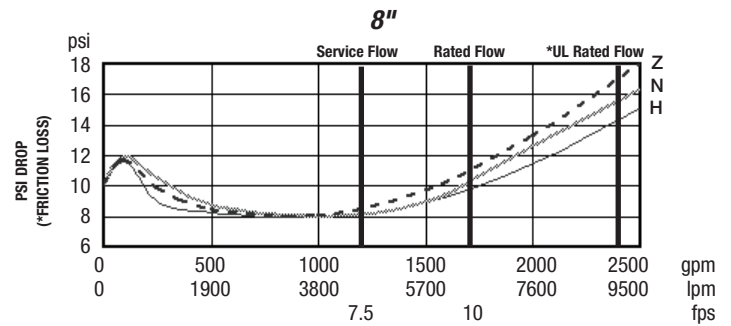
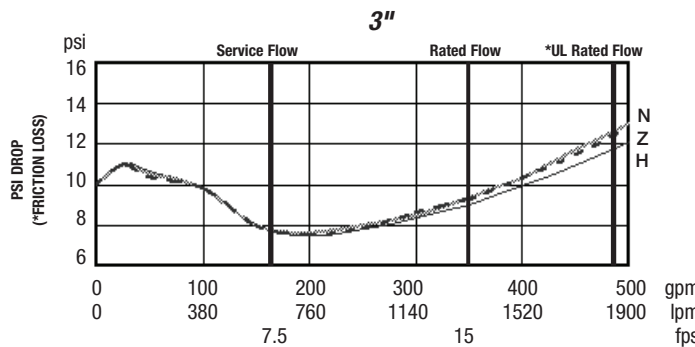
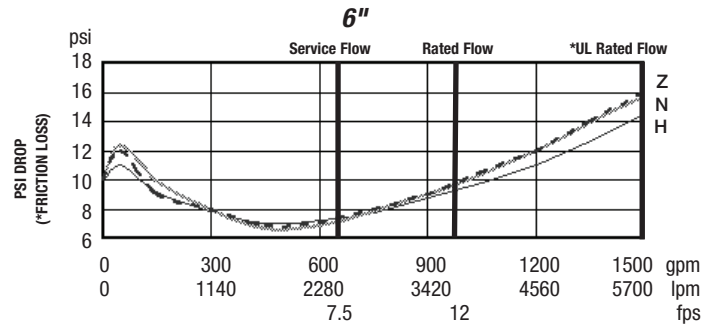
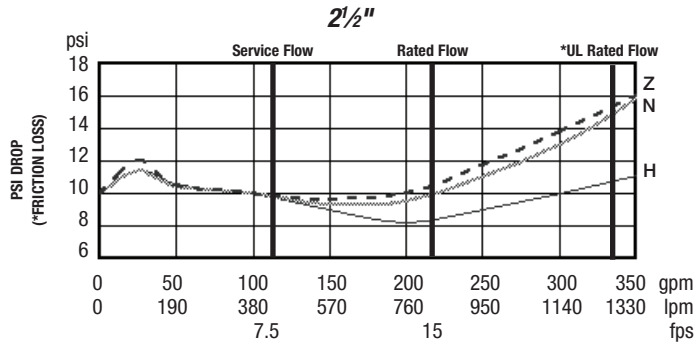

NOTICE

Inquire with governing authorities for local installation requirements



USA: Tel: (978) 689-6066 • Fax: (978) 975-8350 • Watts.com
Canada: Tel: (905) 332-4090 • Fax: (905) 332-7068 • Watts.ca
Latin America: Tel: (52) 55-4122-0138 • Watts.com